

PRESSNET



DONGGUAN XCS MACHINERY CO.,LTD.

FOLDER GLUER
PROFESSIONAL MANUFACTURER

www.dgxc.com.cn

公司两大系列及辅助周边设备

- 汉龙 HL 系列全伺服重型糊箱机 HL-1450/1650/1850/2000/2400/2800AC-A
- 粤龙 YL 系列高速多功能糊盒机 YL-650/800/980/1100/1450PC
- 检糊一体机 YL-650/800/1100PC&JP
- 双拼系列 • 粤龙 YL-1450/1650AB • 汉龙 HL-2000/2400/2800AB

Two main series machines and auxiliary machines are as below:

- HL series,HL-1450/1650/1850/2000/2400/2800 AC-A Full Servo Heavy-duty Automatic Folder Gluer
- YL series,YL-650/800/980/1100/1450PC High-speed Multifunctional Automatic Folder Gluer
- YL series,YL-650/800/1100PC&JP Multifunctional Automatic Folder Gluer with Online Inspection
- YL-1450/1650AB and HL-2000/2400/2800AB Double Feeder Automatic Folder Gluer



Provide High-quality Automatic Folder Gluer for Printing & Packing Industry's Box, Which Including Paperboard Color Box, Corrugated Board Color Carton etc.

Company Profile

DONGGUAN XCS MACHINERY CO.,LTD,we are a high-tech manufacturing enterprise,who specialized in high-quality automatic folder gluer for printing and packing industry color paper boxes, corrugated board boxes, other cardboard boxes etc..

With past years of developing experience and growing professional technology, company has formed a completed organizational structure by R&D department, production department, sales system and after-sale service team. All production workshops follow 6S management which equipped with international CNC machines parts processing center and paint spraying lines equipment,by this way,we can ensure the machine parts processing accuracy and surface treatment quality from beginning till end processes. Besides,to ensure the provided machines have more obvious advantaged performance in the same industry competition,we never stop developing self-technology by integrates the customer's improvement suggestion and senior technician's proprietary practical experience from time to time.

So far,company all series machines have approved by the European CE certification standards, also owned a number of invention patents and technology patent certificates.

Meanwhile,base on some special requirements from customers,company has also successfully developed and launched different model machines for online shopping box, zipper box, express bag, environmental protection sharp bottom bag etc..

Thanks to customers' persistent support and cooperation,we have set up a multichannel marketing branches and service network accordingly,have actively explored the domestic and international markets the same time, to keep our folder gluer production sales capacity and market coverage increase steadily.

In order to meet more & more requirement for high-quality machines,to meet self-sustainable management and development, company has bought and been an owner of 2000sqm industrial land when in March of 2022 year. We expect to launch a total new manufacturing enterprise when in 2025 year.

In the future, we will deepen in the field of high-end folder gluer manufacturing and sure lead the trend of global printing and packaging machinery industry. We also continue to expand the introduction of sophisticated technical personnel, follow with the scientific and technological, intelligent, digital, green environmental protection, high-end machinery intelligent manufacturing of the international enterprise lines.

Let's join hands with friends at home and abroad to create a better and better future!

Main feature

- The front and back alignment servo control is perfectly compatible with all kinds of flat box, special-shaped box etc.
- It is more easier to make the commission with full servo parameterization setting.
- The linear slide rail structure promise the easier adjustment of guide plate, and keep the smooth and stable running.
- The modular design allows for more convenient assembly and disassembly the machine parts.
- Visual inspection to prevent wrong connection of A/B side.
- Creasing line & servo folding can perfectly solve the problem of glue flap folding skewing.
- Equipped with photoelectric counting, can be total count or quantitative count.
- With storage memory function of processed parameters ,can recall back before setting parameters directly in next same job.

HL Series

HL-1650/2000/2400/2800AB

Intelligent Double Feeder Automatic Folder Gluer



Machine layout

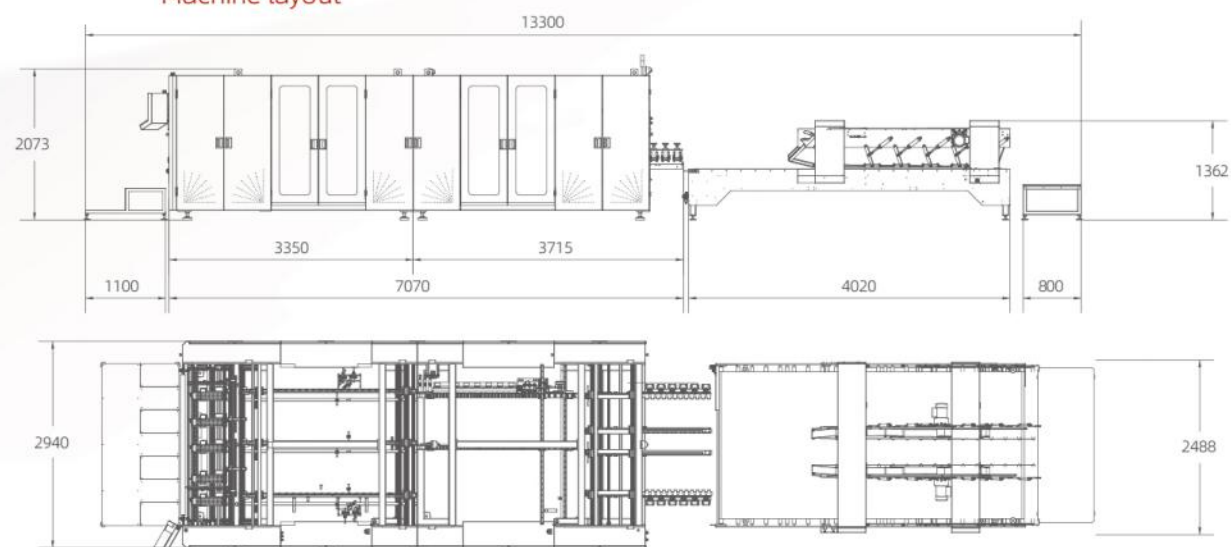

HL Series

HL-1650/2000/2400/2800AB

Intelligent Double Feeder Automatic Folder Gluer

Technical parameter

Model	HL-1650AB	HL-2000AB	HL-2400AB	HL-2800AB
Applicable material	A/B/C/E/EE/BC/EB/AB/BCB		(flute corrugated board)	
Speed range	0~120m/min	0~120m/min	0~120m/min	0~120m/min
Inching speed	20m/min	20m/min	20m/min	20m/min
Max blank width	1650mm	2000mm	2400mm	2800mm
Dimension(L*W*H)	13300*2590*2073mm	13300*2940*2073mm	14230*3340*2073mm	14800*3740*2073mm
Mechanical weight	约 13.5T	约 14.5T	约 16T	约 17.5T
Mechanical power	42KW, AC380V	42KW, AC380V	42KW, AC380V	45KW, AC380V
Max thickness of folded box	<10mm	<10mm	<10mm	<10mm
Compressed air	0.5~0.7Mpa	0.5~0.7Mpa	0.5~0.7Mpa	0.5~0.7Mpa
Air compressor capacity	10 m ³ /h	10 m ³ /h	10 m ³ /h	10 m ³ /h
Air tank capacity	60L	60L	60L	60L

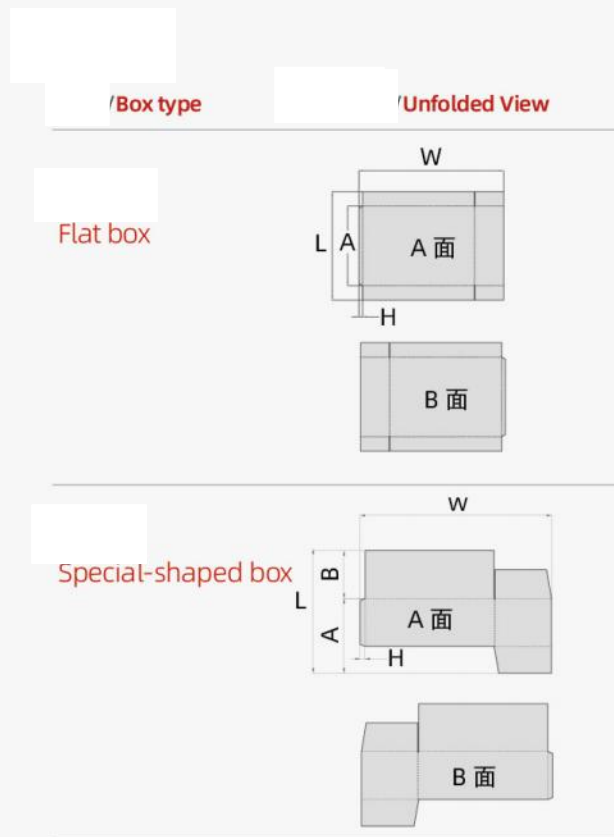

	HL-1650AB	HL-2000AB	HL-2400AB	HL-2800AB
W	500mm-1650mm	500mm-2000mm	500mm-2400mm	500mm-2800mm
L	400mm-1300mm	400mm-1500mm	400mm-1500mm	400mm-1500mm
A	300mm-1000mm	300mm-1000mm	300mm-1000mm	300mm-1200mm
H	三层 /3PLY 30mm-50mm 五层 /5PLY 40mm-50mm 七层 /7PLY 45mm-55mm	三层 /3PLY 30mm-50mm 五层 /5PLY 40mm-50mm 七层 /7PLY 45mm-55mm	三层 /3PLY 30mm-50mm 五层 /5PLY 40mm-50mm 七层 /7PLY 45mm-55mm	三层 /3PLY 30mm-50mm 五层 /5PLY 40mm-50mm 七层 /7PLY 45mm-55mm
B	0mm-200mm	0mm-200mm	0mm-200mm	0mm-200mm



Main feature

- Adopts full servo motor independent drive, equipped with one key adjustment function, memory storage function, and combine single/double feeding in one machine to produce kinds of flat boxes and special-shaped printing corrugated boxes
- Equipped with high-precision modular guide rails for each section, stepper plate shifting motor, moveable and elaborate tooth lever design. It is easy and convenient to operate, fast and high efficiency
- Each functional component adopts modular design, which is convenient to assemble, to shift and debug two job products in shorter time

HL Series

HL-1650/2100AB-M

Intelligent Single/Double Feeder Automatic Folder Gluer



Machine layout

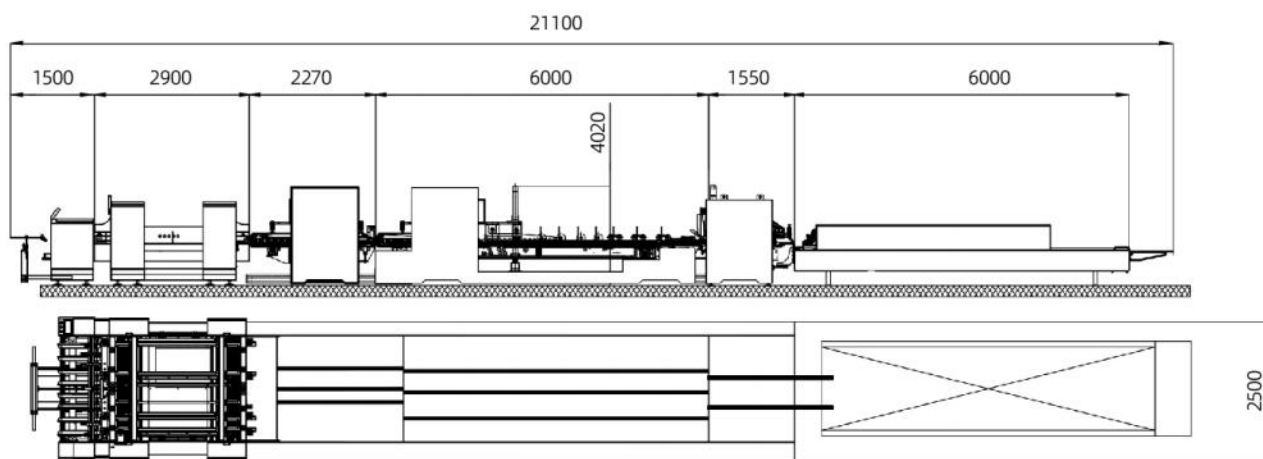

HL Series HL-1650/2100AB-M

Intelligent Single/Double Feeder Automatic Folder Gluer

Technical parameter

Model	HL-1650AB-M	HL-2100AB-M
Suitable material	400-800g/m ² F/E/B/C/EB/EE	Cardboard Flute corrugated board
Box types	Linear box, crash lock bottom box, flat box all can by single feeder or double feeders	
Max feeding width	1650mm	2100mm
Max thickness of folded box		15mm
Feeding method		Automatic continuously feeding
Speed range		MAX.200m/min
Glue type(solute type)		Hotmelt glue + cold glue
Mechanical power	60.5KW/AC220V/380V	60.5KW,AC220V/380V
Mechanical weight	约 17T	约 19T
Dimension(L*W*H)	21100*2500*1800mm	21100*2950*1800mm
Inching speed		20m/min
Compressed air		6 bar
Air compressor capacity		10m ³ /h
Air tank capacity		60 L

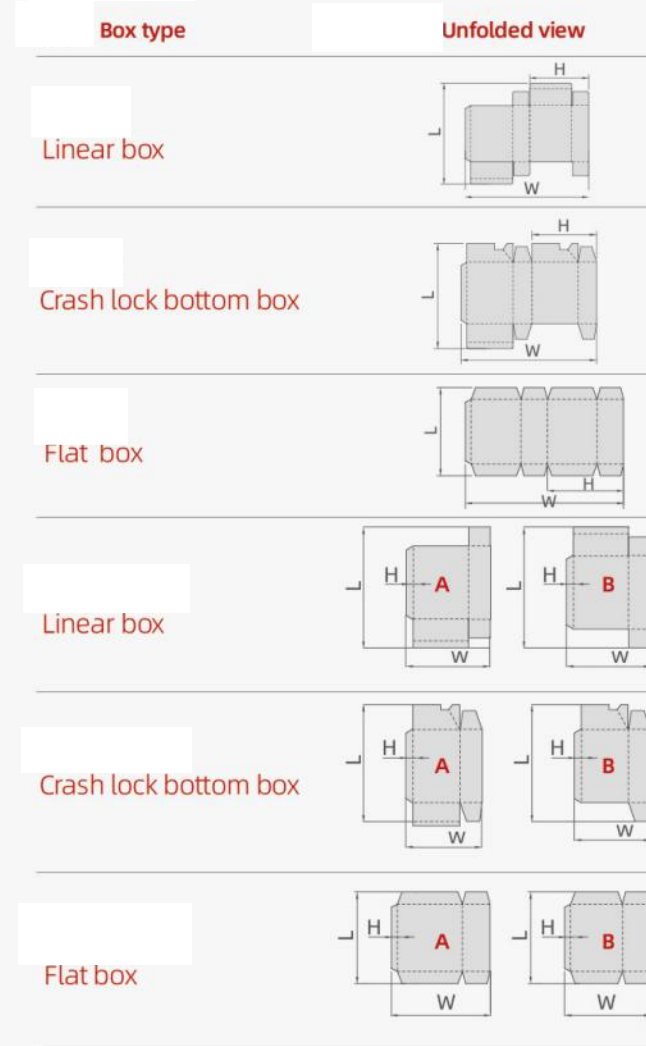

HL-1650AB-M		HL-2100AB-M	
L	1000-160	L	1000-160
W	1650-650	W	2100-650
H	815-310	H	1035-310
L	1000-180	L	1000-180
W	1650-750	W	2100-750
H	815-360	H	1035-360
L	1000 ~ 180	L	1000 ~ 180
W	1650 ~ 650	W	2100 ~ 650
H	815 ~ 310	H	1035 ~ 310
	A	B	
L	1300-300	1300-300	1300-300
W	825-420	825-420	1050-420
H	40-25	40-25	40-25
	A	B	
L	1300-300	1300-300	1300-300
W	825-420	825-420	1050-420
H	40-25	40-25	40-25
	A	B	
L	1300-300	1300-300	1300-300
W	825-420	825-420	1050-420
H	40-25	40-25	40-25

Main feature

- The modular design realizes different functional configurations according to customer requirements, each module driven by independent servo motor, to ensure machines at stable, convenient, accurate, efficient and other performance.
- Equipped with high-precision linear guide rail and electric moving plates device.

HL Series

HL-2000/2400/2800AC-A

Wide Format Heavy-duty Automatic Folder Gluer

HL series wide format heavy-duty folder gluer is mainly applied for the 3 layers and 5 layers color printing corrugated boxes that from rotary die-cutting and slotting processes.



Machine layout

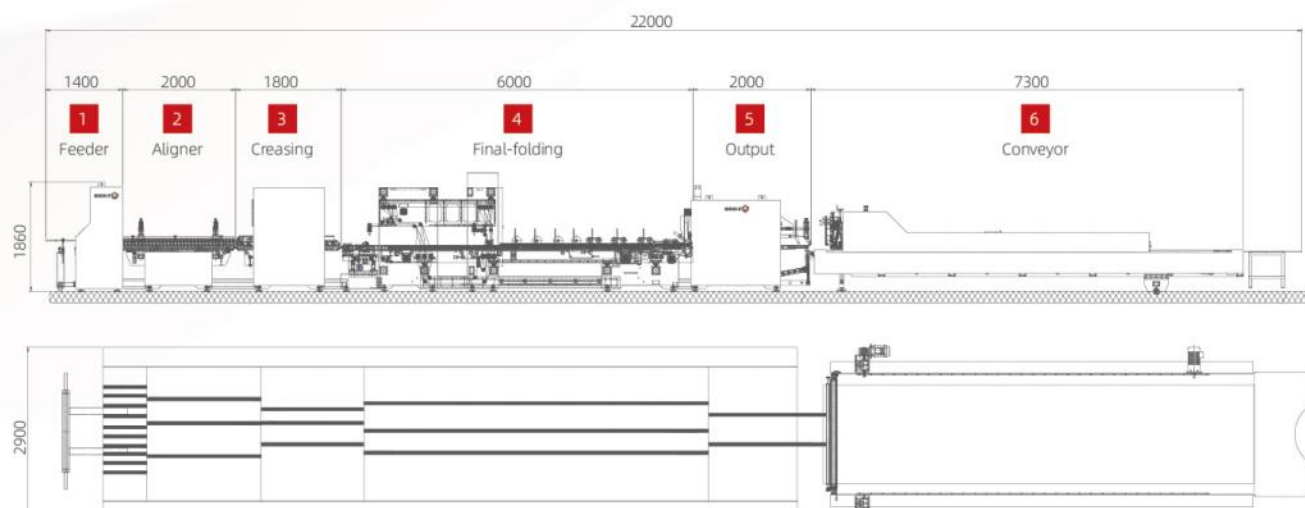

HL Series

HL-2000/2400/2800AC-A

Wide Format Heavy-duty Automatic Folder Gluer

Technical parameter

Model	HL-2000AC-A	HL-2400AC-A	HL-2800AC-A
Applicable material	250~800g/m ² (cardboard) E, C, B (E/C/B flute corrugated board)		
Speed range	0~200m/min	0~200m/min	0~200m/min
Inching speed	30m/min	30m/min	30m/min
Max blank width	2000mm	2400mm	2800mm
Dimension(L*W*H)	22000*2900*1860mm	22000*2900*1860mm	22000*2900*1860mm
Mechanical weight	15.5T	16.5T	17.5T
Mechanical power	56KW	56KW	61KW
Max thickness of folded box	15mm	15mm	15mm
Compressed air	6 bar	6 bar	6 bar
Air compressor capacity	10 m ³ /h	10 m ³ /h	10 m ³ /h
Air tank capacity	60L	60L	60L

Box parameter

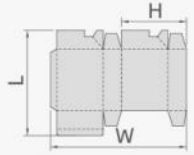
Box type	Unfolded view	HL-2000AC-A	HL-2400AC-A	HL-2800AC-A
Linear box		L 140 ~ 1300 W 650 ~ 2000 H 310 ~ 980	L 140 ~ 1300 W 650 ~ 2400 H 310 ~ 1180	L 140 ~ 1300 W 650 ~ 2800 H 310 ~ 1380
Crash lock bottom box		L 140 ~ 1300 W 750 ~ 2000 H 360 ~ 980	L 140 ~ 1300 W 750 ~ 2400 H 360 ~ 1180	L 140 ~ 1300 W 750 ~ 2800 H 360 ~ 1380
Flat box		L 280 ~ 1000 W 650 ~ 2000 H 310 ~ 980	L 280 ~ 1000 W 650 ~ 2400 H 360 ~ 1180	L 280 ~ 1000 W 650 ~ 2800 H 360 ~ 1380

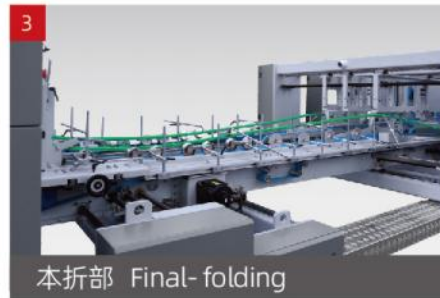

- Independent motor drive
- Adjustable vibration motor
- The side baffle is equipped with motor to adjust the width
- Three sets of adjustable feeder knives
- Adopt high performance suction belts to realize the stability of paper feeding
- Special secondary creasing function device
- Equipped with four sets of main drive creasing wheels
- The cylinder regulates the pressure of the lines creasing wheels
- Can effectively improve the bellmouth and tolerance of final-folding boxes
- Upper and lower belt double drive main transmission system, to ensure smooth delivery of three and five layer cartons
- Left and right inflection belts by independent servo drive, the end of final-folding is equipped with independent belts extrusion function

- Servo motor independent drive
- Electric adjustment length of upper and lower bracket telescopic rod
- Equipped with automatic belt tension adjustment system

Main feature

- Optional for one-button adjustment, intelligent memory and storage functions.
- The modular design realizes different functional configurations according to customer needs, Each group of modules adopts servo motors, which are driven independently and have stable, convenient, accurate and efficient performance.
- Equipped with high-precision linear guide rail and electric plate moving device.

HL Series

HL-1450/1650/1850PC-A

Multifunctional Heavy-duty Automatic Folder Gluer

HL series wide format heavy-duty folder gluer is mainly applied for the 3 layers and 5 layers color printing corrugated boxes that from rotary die-cutting and slotting processes.



Machine layout

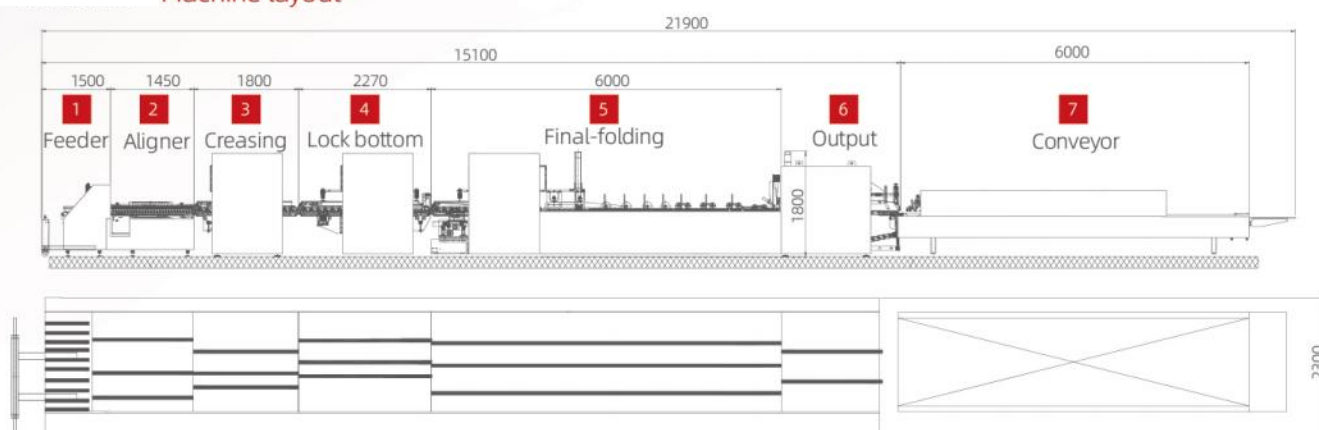

HL Series

HL-1450/1650/1850PC-A

Multifunctional Heavy-duty Automatic Folder Gluer

Technical parameter

Model	HL-1450PC-A	HL-1650PC-A	HL-1850PC-A
Applicable material	250~800g/m ² (cardboard) E、C、E (E/C/B flute corrugated board)		
Speed range	0~200m/min	0~200m/min	0~200m/min
Inching speed	30m/min	30m/min	30m/min
Max blank width	1450mm	1650mm	1850mm
Dimension(L*W*H)	21900*2300*1860mm	21900*2500*1860mm	21900*2700*1860mm
Mechanical weight	13.5T	14.5T	15.5T
Mechanical power	约 54KW	约 56KW	约 56KW
Max thickness of folded box	15mm	15mm	15mm
Compressed air	6 bar	6 bar	6 bar
Air compressor capacity	10 m ³ /h	10 m ³ /h	10 m ³ /h
Air tank capacity	60L	60L	60L

Box parameter

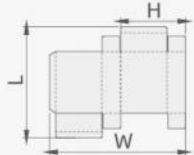
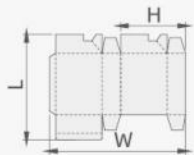
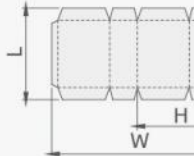
Box type	Unfolded view	HL-1450PC-A	HL-1650PC-A	HL-1850PC-A
Linear box		L 140 ~ 1300 W 650 ~ 1450 H 310 ~ 710	L 140 ~ 1300 W 650 ~ 1650 H 310 ~ 810	L 140 ~ 1300 W 650 ~ 1850 H 310 ~ 910
Crash lock bottom box		L 140 ~ 1300 W 750 ~ 1450 H 360 ~ 710	L 140 ~ 1300 W 750 ~ 1650 H 360 ~ 810	L 140 ~ 1300 W 750 ~ 1850 H 310 ~ 910
Flat box		L 280 ~ 1000 W 650 ~ 1450 H 310 ~ 710	L 280 ~ 1000 W 650 ~ 1650 H 310 ~ 810	L 280 ~ 1000 W 650 ~ 1850 H 310 ~ 910



- Independent servo motor drive
- Adjustable vibration motor
- The right baffle is equipped with motor to actively adjust the width
- Three sets of adjustable feeder knives
- Adopt high performance suction belt to realize the stability of paper feeding

- Special secondary creasing function device
- Equipped with four sets of main drive creasing wheels
- The cylinder regulates the pressure of the lines creasing wheels
- Can effectively improve the bellmouth and tolerance of final-folding boxes
- The main wall panel is equipped with a motor to adjust the width automatically

- The whole set of front bottom locking device ensures the smooth and accurate bottom locking operation
- B type lock bottom box accessories, easy and fast operation and control
- The main wall panel is equipped with a motor to adjust the width automatically

- Upper and lower both independent servo motor drive
- Upper conveyor equipped with independent motor for the forward and backward moving adjustment according to different box lengths
- Equipped with pneumatic pressure control system, easy to adjust, can effectively ensure the uniform pressure

Main feature

- Belonging to YL series heavy-duty folder gluer, and the machine overall frame is made of 20mm thick high-quality carbon steel.
- The modular design can meet different requirements from customers, and be more easier installation and operation, also be more effective to solve the production of special-shaped boxes.
- The transmission mode of the whole machine adopts hexagonal axis and multi wedge belts, by this way, machine is more efficient, energy-saving and noiseless.
- The upper and lower dual power driving, ensures smooth paper delivery and accurate folding line, which can meet many kinds of cardboard boxes gluing requirements.

YL Series

YL-1450/1650PC-B

Multifunctional Automatic Folder Gluer



Machine layout

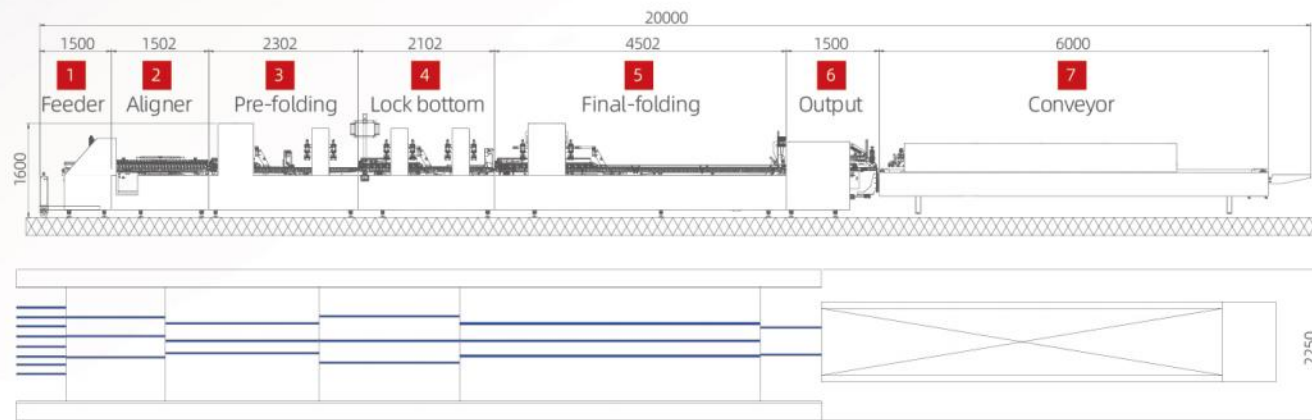

YL Series

YL-1450/1650PC-B

Multifunctional Automatic Folder Gluer

Technical parameter

Model	YL-1450PC-B	YL-1650PC-B
Applicable material	200 ~ 800g/ N-E-F-B	(cardboard) (N/E/F/B flute corrugated board)
Speed range	0 ~ 300m/min	0 ~ 300m/min
Inching speed	30m/min	30m/min
Max blank width	1450mm	1650mm
Dimension(L*W*H)	20000*2250*1600mm	20000*2250*1600mm
Mechanical weight	约 11.5T	约 12T
Mechanical power	约 29kW	约 32.5kW
Max thickness of folded box	15mm	15mm
Compressed air	6bar	6bar
Air compressor capacity	10 m ³ /h	10 m ³ /h
Air tank capacity	60L	60L

Box parameter

Box type	Unfolded view	YL-1450PC-B	YL1650PC-B
Linear box		L 140 ~ 1000 W 260 ~ 1450 H 120 ~ 715	L 140 ~ 1000 W 260 ~ 1650 H 120 ~ 815
Crash lock bottom box		L 140 ~ 1000 W 270 ~ 1450 H 125 ~ 715	L 140 ~ 1000 W 270 ~ 1650 H 125 ~ 815
Four corner box		L 140 ~ 1000 W 240 ~ 1050 H 30 ~ 150	L 140 ~ 1000 W 240 ~ 1050 H 30 ~ 150
Six corner box		L 140 ~ 1000 W 330 ~ 1400 H 30 ~ 150	L 140 ~ 1000 W 330 ~ 1600 H 30 ~ 150
Flat box		L 180 ~ 1000 W 450 ~ 1450 H 210 ~ 715	L 180 ~ 1000 W 450 ~ 1650 H 210 ~ 815

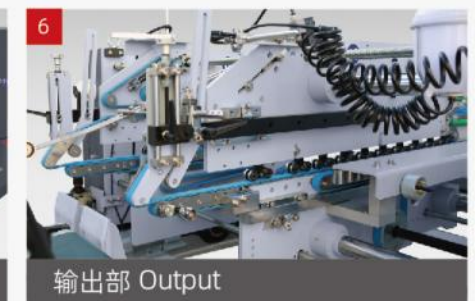
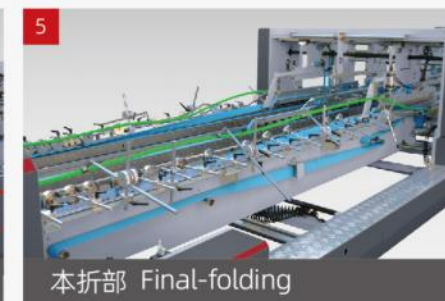
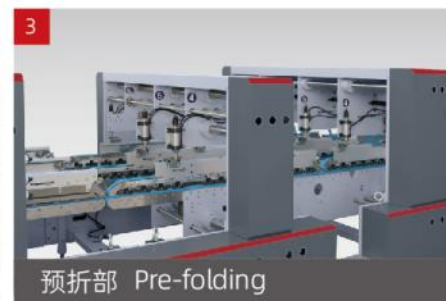
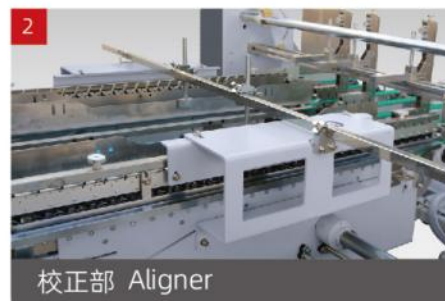

- Independent servo motor drive
- Adjustable vibration motor
- Three sets of adjustable feeder knives
- Adopt high performance suction belts to realize the stability of paper feeding
- Independent adjustable side aligner, the lower bracket which is not parallel to the wall board stretches the paper to be transported along a parallel guide device to ensure that the paper is parallel and aligned
- Simple, fast and flexible operation
- Left upper left 180° pre -folded
- The third creasing line 135° pre - folded
- With the pre-folding open device for 1st and 3rd creasing line

- The whole front bottom locking device ensures smooth and accurate bottom locking action
- B type bottom lock box accessories
- The upper and lower belts main drive to ensure paper delivery smoothly
- The middle plate adopts pneumatic lifting to facilitate the production of small box with left and right guide plates
- The telescopic rod of upper and lower brackets can be adjusted independently
- Equipped with automatic belt tension adjustment system

Main feature

- The simple and ingenious design makes YL series folder gluer as the first choice machine that favoured by many customers.
- Modular design, can meet different requirements from customers; and be more easier installation and operation, also be more effective to solve the production of special-shaped boxes.
- The transmission mode of the whole machine adopts hexagonal axis and multi wedge belts, by this way, machine is more efficient, energy-saving and noiseless.
- Follow the lightweight design principle, reduce energy consumption and achieve more simple and convenient operation.

YL Series

YL-1100PC-B

High-speed Automatic Multifunctional Folder Gluer

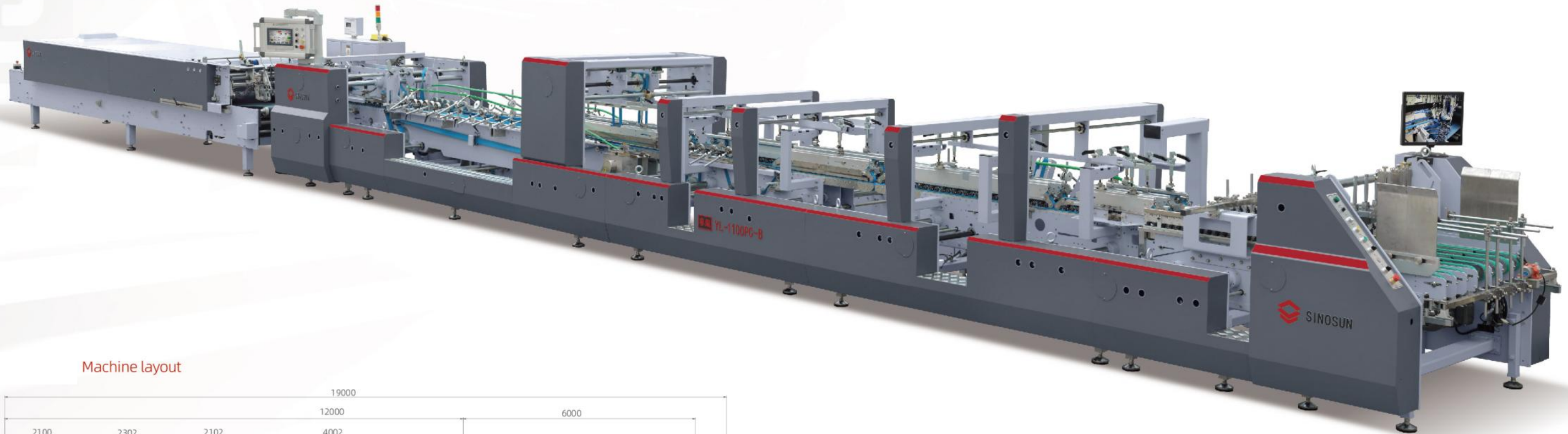

Machine layout

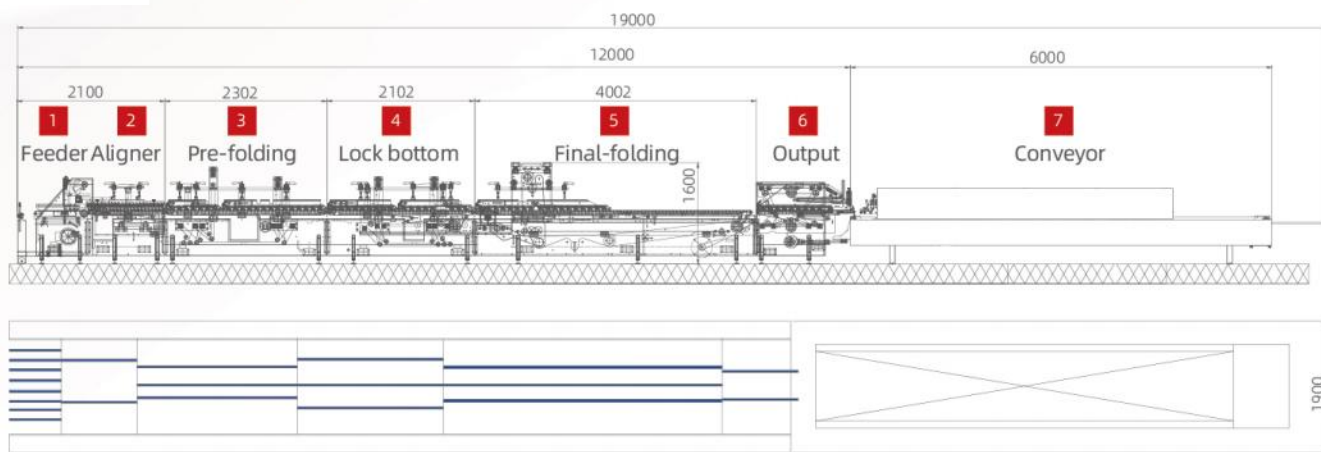

YL Series

YL-1100PC-B

High-speed Automatic Multifunctional Folder Gluer

Technical parameter

Model	YL-1100PC-B	YL-1100PC-C
Applicable material	200 ~ 800g/m ² (cardboard) N-E-F (N/E/F flute corrugated board)	
Speed range	0 ~ 400m/min	
Inching speed	30m/min	
Max blank width	1100mm	
Dimension(L*W*H)	19000*1900*1600mm	
Mechanical weight	9.5T	约 10T
Mechanical power	22.5KW	约 26.5KW
Max thickness of folded box	15mm	
Compressed air	6bar	
Air compressor capacity	10 m ³ /h	
Air tank capacity	60L	

Box parameter

Box type	Unfolded view	YL-1100PC-B/C	YL-1100PC-C
Linear box		L 140 ~ 1000 W 230 ~ 1100 H 105 ~ 540	
Crash lock bottom box		L 140 ~ 1000 W 240 ~ 1100 H 110 ~ 540	L 140 ~ 1000 W 300 ~ 1100 H 140 ~ 540
Four corner box		L 140 ~ 1000 W 210 ~ 1050 H 30 ~ 150	
Six corner box		L 140 ~ 1000 W 310 ~ 1050 H 30 ~ 150	
Flat box		L 150 ~ 500 W 400 ~ 1100 H 190 ~ 540	

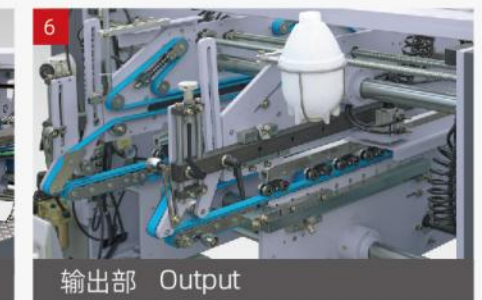
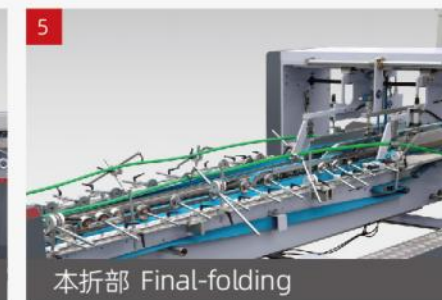
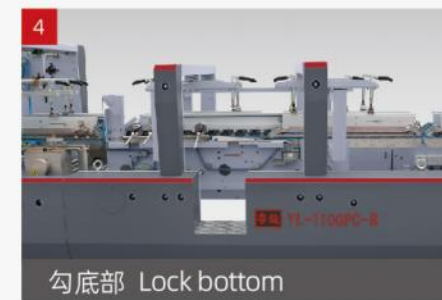
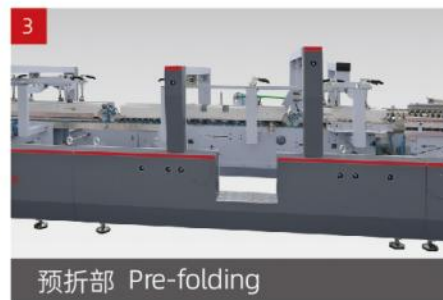

- Independent servo motor drive
- Adjustable vibration motor
- Two sets of adjustable feeder knives
- Adopt high performance suction belts to realize the stability of paper feeding
- Independent adjustable side aligner, the lower bracket which is not parallel to the wall board stretches the paper to be transported along a parallel guide device to ensure that the paper is parallel and aligned
- Simple, fast and flexible operation
- Left upper left 180° pre -folded
- The third creasing line 135° pre - folded
- With the pre - folding open device for 1st and 3rd creasing line

- The whole set of front bottom locking device ensures the smooth and accurate bottom locking operation
- B type lock bottom box accessories
- The upper and lower belts main drive to ensure paper delivery smoothly
- The middle plate adopts pneumatic lifting to facilitate the production of small box with left and right guide plates
- The telescopic rod of upper and lower brackets can be adjusted independently
- Equipped with automatic belt tension adjustment system

Main feature

- Adopts domestic advanced technology to provide a perfect production solution for box forming, with high production efficiency, powerful functions, flexibility and variety.
- The modular design can meet different requirements from customers, and be more easier installation and operation, also be more effective to solve the production of special-shaped boxes.
- Adopts with hookless design technology and guide plate climbing structure, which help to realize the automatic bottom locking and four/six corner box function.
- Equipped with high-precision linear guide rail, greatly improving the accuracy and durability of the machine.

YL Series

YL-1100PC-C

High-speed Automatic Multifunctional Climbing Folder Gluer



Machine layout

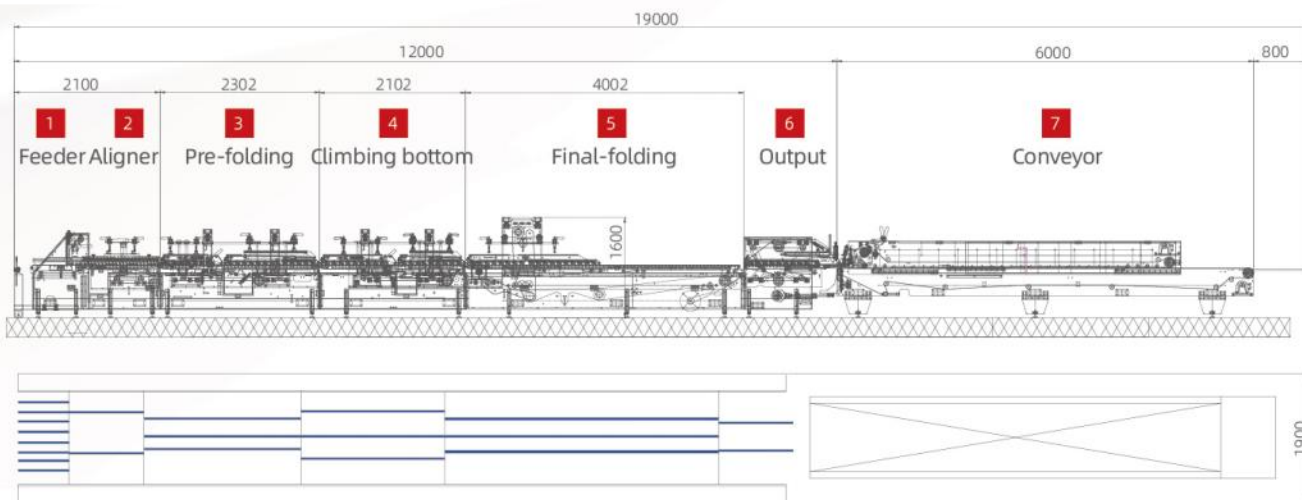

Main feature

- According to the characteristics of the printing process, folder gluer adopts integrated mode with inspection function, and the waste detection system is equipped to improve the production efficiency. To ensure that the quality of finished boxes can be guaranteed during high-speed production.
- By selecting different areas inspection, can detect full printing quality such as missed printing, white spot, color difference and incomplete font etc..
- Powerful detection algorithm to adapt to different customers' different requirements for quality; The operation is simple. The detection parameters can be saved and called again, and the parameter can be called back in a few seconds.

YL Series

YL-650/800/1100PC&JP

High-speed Automatic Multifunctional Folder Gluer with Online Inspection

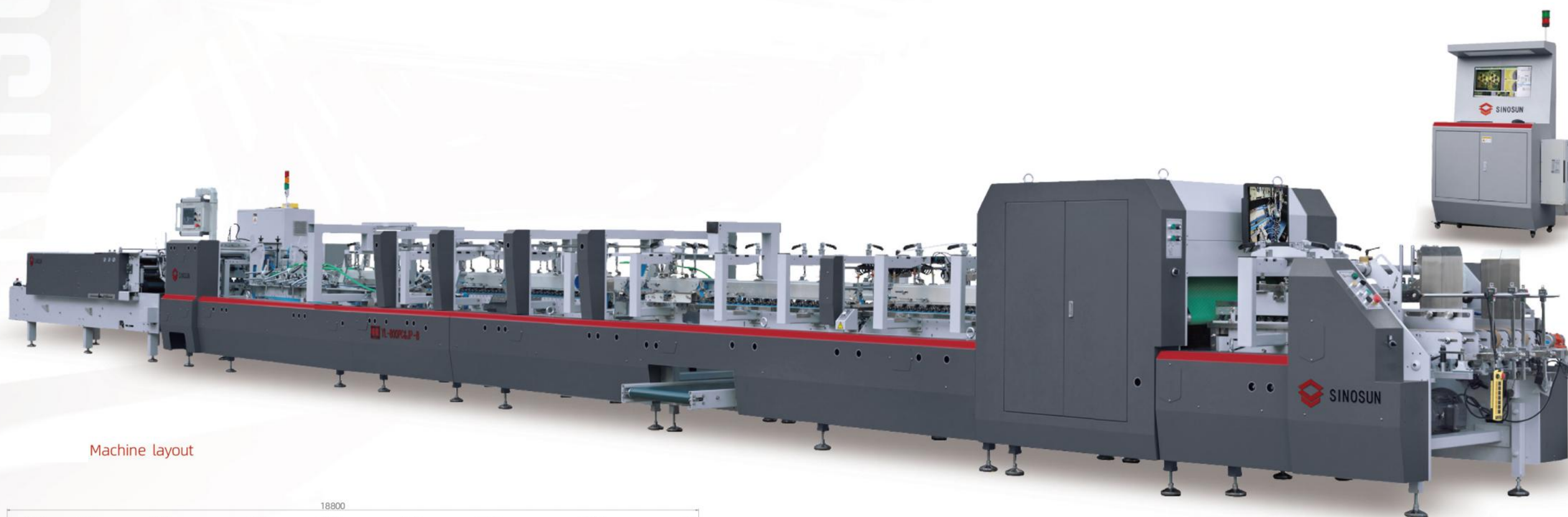

Machine layout

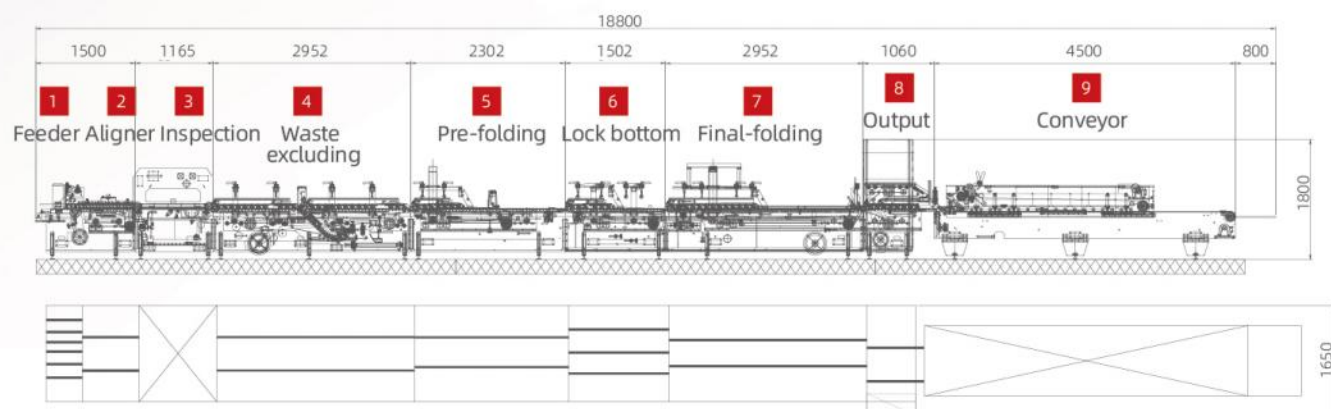

YL Series

YL-650/800/1100PC&JP

High-speed Automatic Multifunctional Folder Gluer with Online Inspection

Technical parameter

Model	YL-650PC&JP	YL-800PC&JP	YL-1100PC&JP
Applicable material	200~650g/m ² (cardboard)		
Speed range	0 ~ 400m/min	0 ~ 400m/min	0 ~ 400m/min
Inching speed	30m/min	30m/min	30m/min
Max blank width	650mm	800mm	1100mm
Dimension(L*W*H)	18800*1650*1800mm	18800*1800*1800mm	20000*2100*1800mm
Mechanical weight	8.5T	9T	10.5T
Mechanical power	28KW	34KW	38KW
Max thickness of folded box	12mm	12mm	12mm
Compressed air	6 bar	6 bar	6 bar
Air compressor capacity	10 m ³ /h	10 m ³ /h	10 m ³ /h
Air tank capacity	60L	60L	60L



- Equipped with professional cameras and lenses, the high-speed operation is still accurate and stable
- Adopted with vacuum suction theory, to ensure the smooth delivery box, which is characterized by low power, low noise and energy saving
- Easy operation, the inspection parameters can be saved and called again, and the parameter can be called back in a few seconds
- Multi air nozzle combination, air nozzle position can be adjusted according to the box types, non-contact waste excluding method can help avoiding secondary scratches
- Equipped with independent and convenient waste collection device

Technical parameter

Model	YL-650/800/1100PC&JP		
Front inspection item			
Min.defect inspection accuracy	0.15mm	0.25mm ²	0.15mm ² (high contract) 0.25mm ² (low contract)
Min.linear defect inspection size	≥0.15mm	≥5mm	width≥0.15mm length≥5mm(high contrast) width≥0.25mm length≥5mm(low contrast)
Image acquisition resolution	0.15mm 0.1mm	×0.15mm ×0.15mm	4K camera: 0.15mm(width) x 0.15 mm(length) 8K camera: 0.1mm(width) x 0.15mm(length)
Min.color difference inspection	ΔE ≥3		ΔE ≥3
Overprint deviation inspection	±0.15mm		±0.15mm
Customer code inspection item			
Inspection content			Variable code recognition ,comparison and appearance inspection QR code,digital code,electronic regulatory code,Code 1 28C,20digits Comply with the drug regulatory code printing specification
Barcode types			Recognize and compare the repeated code,misssed code ,error code Barcode dirty, barcode corner missing,number missing,number dirty,printing shift
Data comparison error type			
Appearance inspection error type			
Back inspection item			
Min.defect inspection accuracy	0.2mm ²	0.4mm ²	0.2mm ² (high contract) 0.4mm ² (low contract)
Image acquisition resolution	8k 0.15mm	×0.15mm	8K camera: 0.15mm(width) x 0.15 mm(length)

Note: High contrast indicates the average gray level difference between defection and background is ≥ 30DN (gray level)
Low contrast indicates the average gray level difference between defection and background is ≥ 10DN and ≤ 30DN

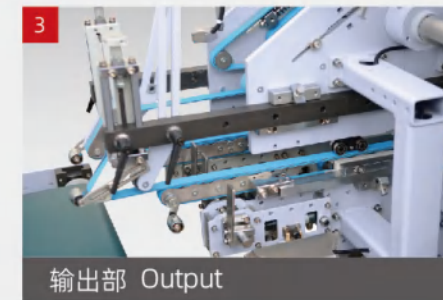

- The upper and lower brackets are driven separately,easy to adjust each length
- Equipped with belts tension automatic adjustment system
- Continuous and automatic box collection method can ensure well queued boxes transferred to the conveyor section

Main feature

- Adopts full servo motor independent drive, intelligent one key adjustment, memory function and lightweight design
- Equipped with high-precision modular guide rails for each section, stepping motor moving plate device, moveable and elaborate tooth lever design. It is easy and convenient to operate, fast and high efficiency
- Each conveyor belt is driven independently by servo motors, power transmission with no drive shaft design, with low noise, high efficiency, easy maintenance and economic efficiency
- Each functional component adopts modular design, which is convenient to assemble, to shift and debug two jobs in shorter time

YZ Series

YZ-650/800/980PC-B

Intelligent High-speed Multifunctional Automatic Folder Gluer

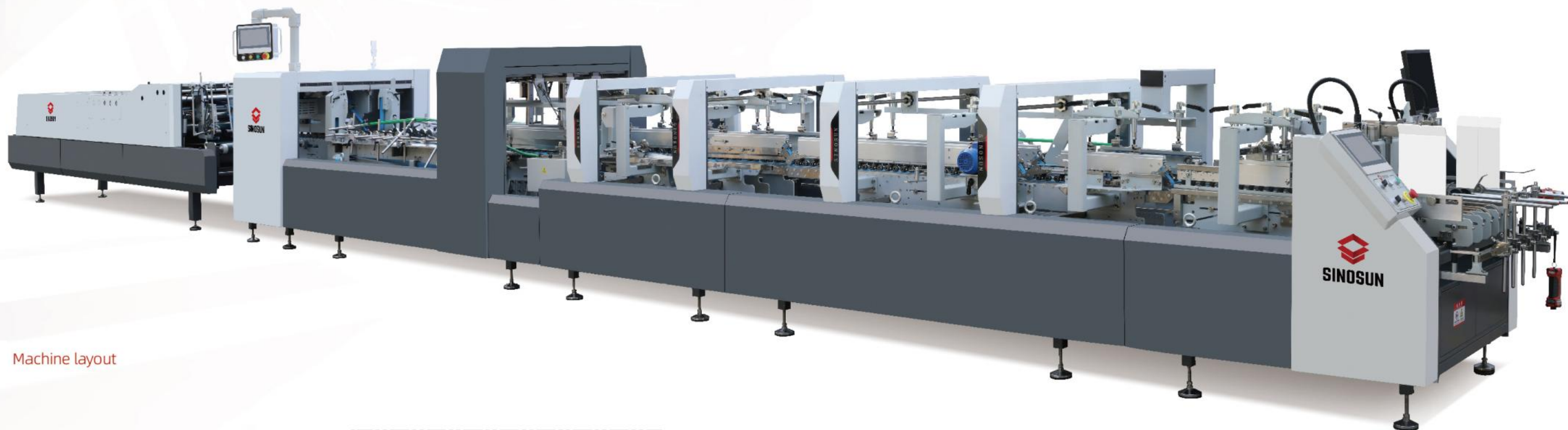

Machine layout

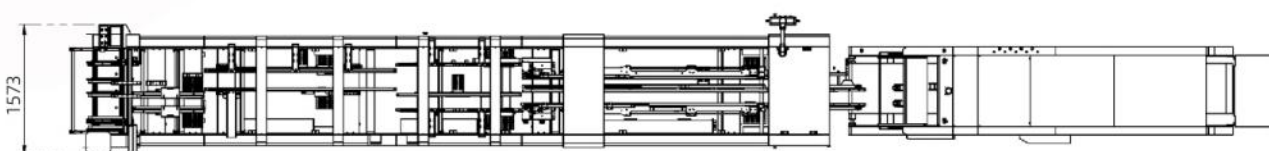
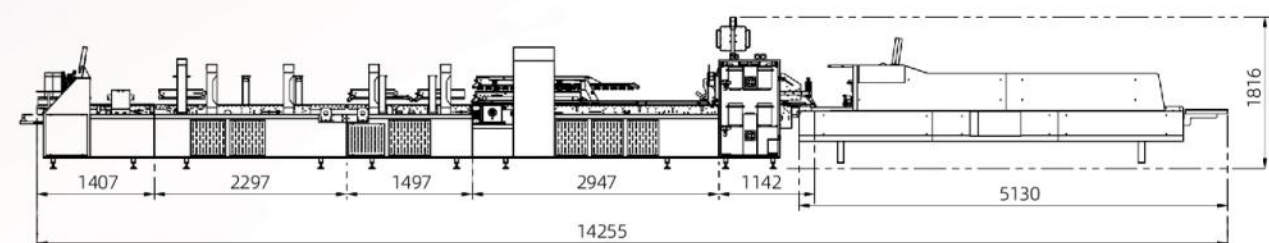

YZ Series

YZ-650/800/980PC-B

Intelligent High-speed Multifunctional Automatic Folder Gluer

Technical parameter

Model	YZ-650PC-B	YZ-800PC-B	YZ-980PC-B
Suitable material	200-650g/ m ² Cardboard	200-800g/ m ² E/F/N Cardboard	Flute corrugated board
Speed range	MAX.400m/min		
Inching speed	30m/min		
Max feeding width	650mm	800mm	980mm
Dimension(L*W*H)	14225*1423*1816mm	14225*1573*1816mm	14225*1753*1816mm
Mechanical weight	约 6.5T	约 7T	约 7.5T
Mechanical power	约 38KW	约 40KW	约 40KW
Max thickness of folded box	12mm	15mm	15mm
Compressed air	6 bar		
Air compressor capacity	10m ³		
Air tank capacity	60L		

Box parameter

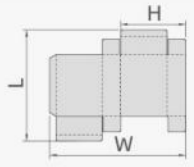
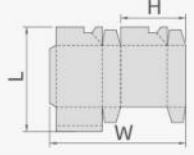
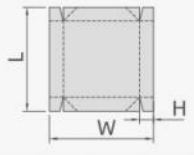
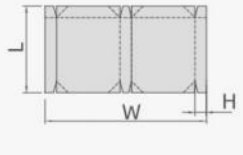
Box type	Unfolded view	YZ-650PC-B	YZ-800PC-B	YZ-980PC-B
Linear box		L 800-120mm W 650-150mm H 315-70mm	800-120mm 800-150mm 390-70mm	800-120mm 980-150mm 480-70mm
Crash lock bottom box		L 800-120mm W 650-170mm H 315-80mm	800-120mm 800-170mm 390-80mm	800-120mm 980-170mm 480-80mm
4 Corner box		L W H	800-120mm 750-150mm 150-20mm	800-120mm 950-150mm 150-20mm
6 Corner box		L W H	800-120mm 750-260mm 120-20mm	800-120mm 950-260mm 120-20mm

Main feature

- Follow the lightweight design, can help reducing noise, improve machine controllability and reliability
- The modular design can perfectly adapted to many kinds of boxes, the optional mechanical parts are easy to disassemble and install back.
- The transmission mode of the whole machine adopts hexagonal axis and multi wedge belts, by this way, machine is more efficient, energy-saving and noiseless.
- The feeder, main folding, output are all adopted with independent motors, frequency conversion speed regulation and linkage.

YL-650/800/980PC-B

High-speed Automatic Multifunctional Folder Gluer

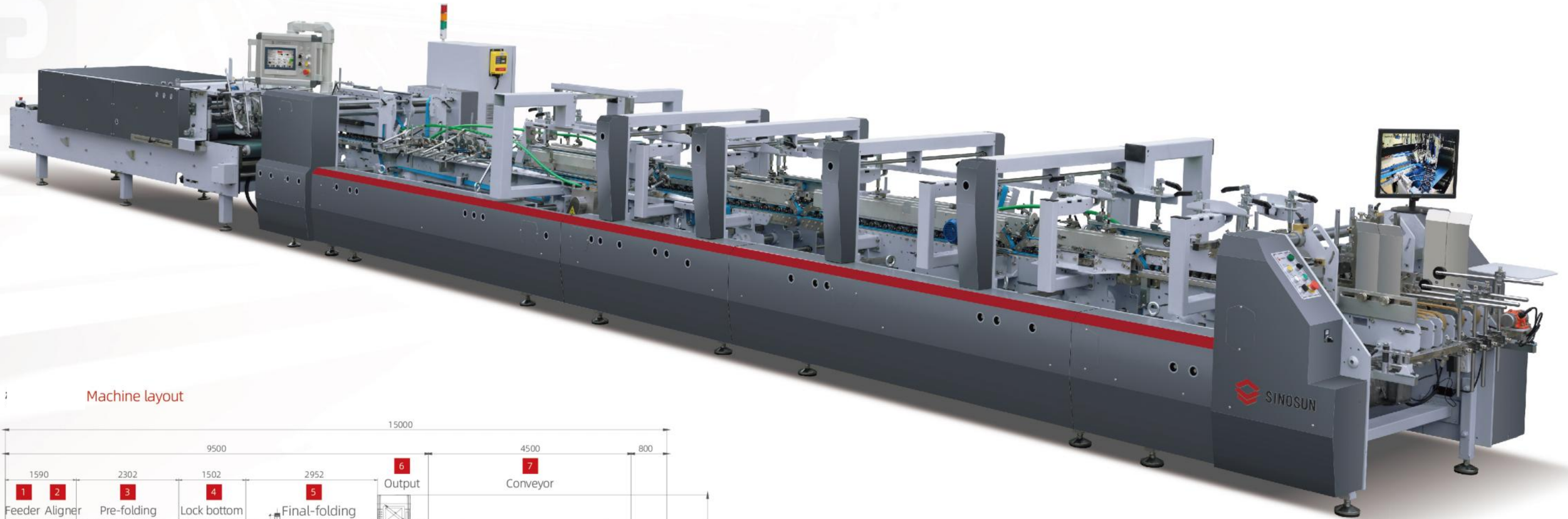

Machine layout

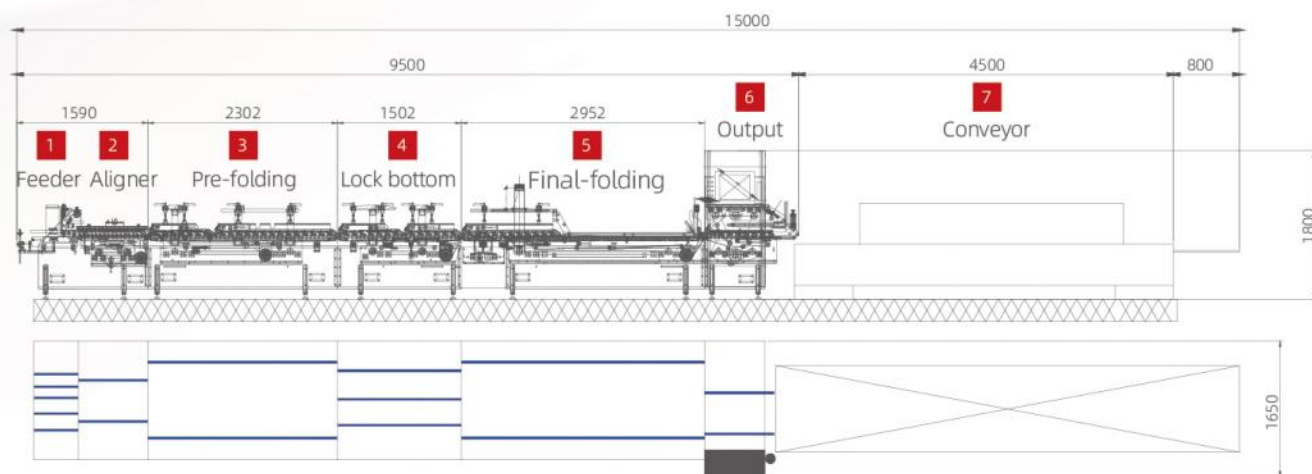

YL Series

YL-650/800/980PC-B

High-speed Automatic Multifunctional Folder Gluer

Technical parameter

Model	YL-650PC-B	YL-800PC-B	YL-980PC-B
Applicable material	200~800g/m ² (cardboard) (E/N/F flute corrugated board)		
Speed range	0~400m/min	0~400m/min	0~400m/min
Inching speed	30m/min	30m/min	30m/min
Max blank width	650mm	800mm	980mm
Dimension(L*W*H)	15000*1650*1800mm	15000*1800*1800mm	15000*2000*1800mm
Mechanical weight	约 6T	约 6.5T	约 7T
Mechanical power	约 16.5KW	约 16.5KW	约 16.5KW
Max thickness of folded box	12mm	15mm	15mm
Compressed air	6 bar	6 bar	6 bar
Air compressor capacity	10 m ³ /h	10 m ³ /h	10 m ³ /h
Air tank capacity	60L	60L	60L

Box parameter

Box type	Unfolded view	YL-650PC-B	YL-800PC-B	YL-980PC-B
Linear box		L 100 ~ 800 W 130 ~ 650 H 60 ~ 310	L 100 ~ 800 W 130 ~ 800 H 60 ~ 390	L 100 ~ 800 W 130 ~ 980 H 60 ~ 480
Crash lock bottom box		L 100 ~ 800 W 170 ~ 600 H 80 ~ 290	L 100 ~ 800 W 170 ~ 800 H 80 ~ 390	L 100 ~ 800 W 170 ~ 980 H 80 ~ 480
Four corner box		L 130 ~ 800 W 150 ~ 500 H 20 ~ 150	L 130 ~ 800 W 150 ~ 800 H 20 ~ 150	L 130 ~ 800 W 150 ~ 930 H 20 ~ 150
Six corner box		L 130 ~ 800 W 250 ~ 650 H 30 ~ 150	L 130 ~ 800 W 250 ~ 800 H 30 ~ 150	L 130 ~ 800 W 250 ~ 930 H 30 ~ 150



给纸部 Feeder



纠偏部 Aligner

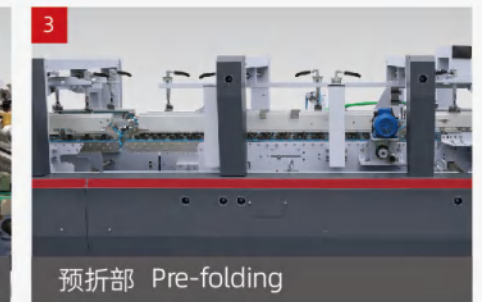

预折部 Pre-folding

- Independent servo motor drive, with variable speed
- Adjustable vibration motor
- Feeder side baffles can adjust the width
- Two adjustable front feeder knives

- Independent adjustable side aligner, the lower bracket which is not parallel to the wall board stretches the paper to be transported along a parallel guide, device to ensure that the paper is parallel and aligned

- Left upper left 180° pre-folded
- The third creasing line 135° pre-folded
- With the pre-folding open device for 1st and 3rd creasing line



勾底部 Lock bottom

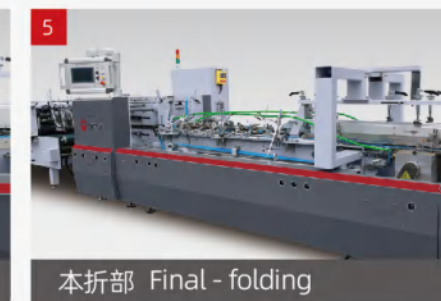

本折部 Final - folding



输出部 Output

- The whole set of frontal lock device ensures the smooth and accurate operation of the bottom lock
- B type lock box accessories

- Smoothly and accurately finish the second fold line, the fourth fold line 180° combined
- Outer folding belts adjustable up to 180° with variable speed
- Two upper and two lower carriers with 25mm lower and 30mm outer belts
- Width adjustable heavy duty compression rollers(optional)

- Upper and lower brackets are driven separately, easy to adjust each length
- Equipped with belts tension automatic adjustment system
- Continuous and automatic box collection method can ensure well queued boxes transferred to the conveyor section



输送机 Conveyor

- The speed of the delivery pressure part can be adjusted automatically or manually according to the speed of the host machine
- Depending on the length of the box, the output pressure part can move forward and backward

Main feature

- Follow the lightweight design, can help reducing noise, improve machine controllability and reliability
- The modular design can perfectly adapted to many kinds of boxes, the optional mechanical parts are easy to disassemble and install back.
- The transmission mode of the whole machine adopts hexagonal axis and multi wedge belts, by this way, machine is more efficient, energy-saving and noiseless.
- The feeder, main folding, output are all adopted with independent motors, frequency conversion speed regulation and linkage.

YL Series

YL-800/980PC-C

High-speed Automatic Multifunctional Climbing Folder Gluer

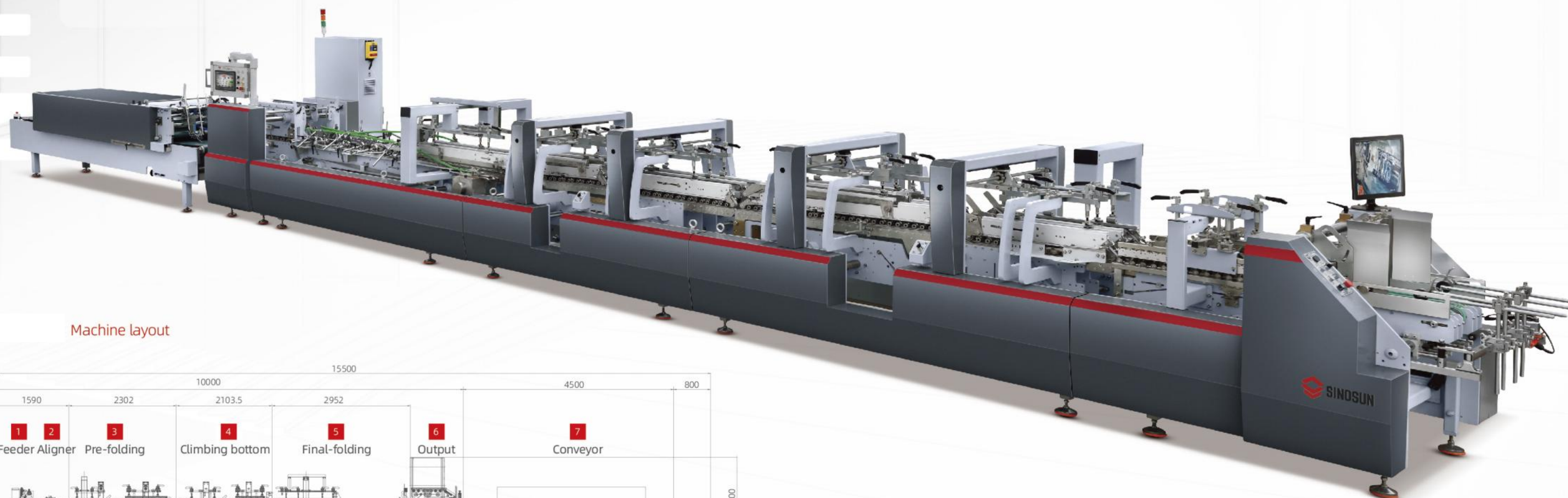

Machine layout

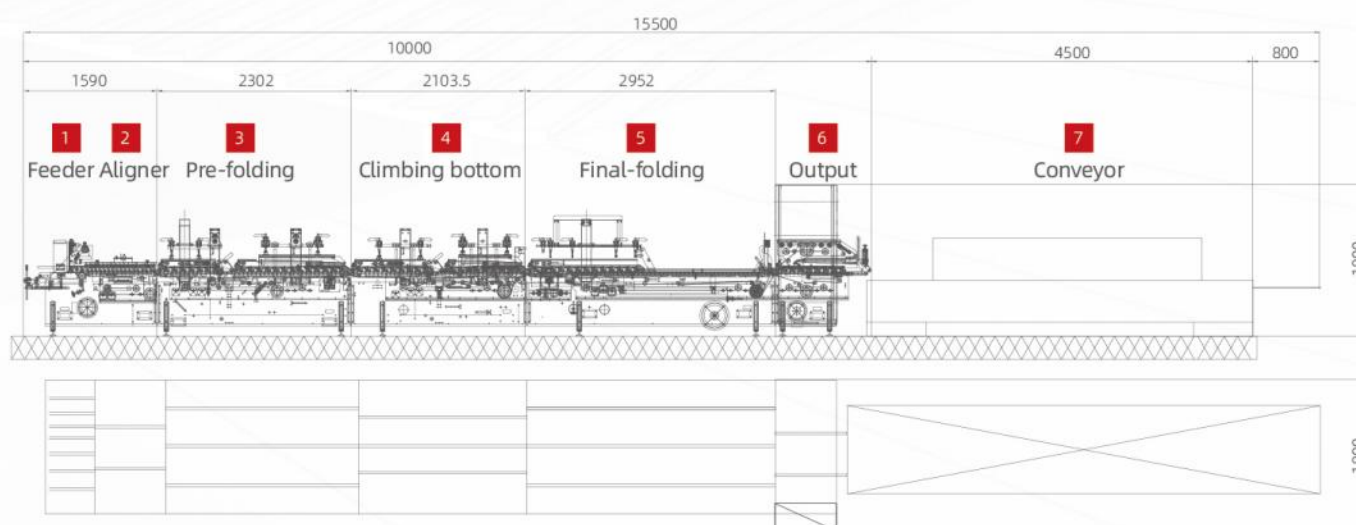

YL Series YL-800/980PC-C

High-speed Automatic Multifunctional Climbing Folder Gluer

Technical parameter

Model	YL-800PC-C	YL-980PC-C
Applicable material	200~800g/m ² (cardboard) (N/E/F flute corrugated board)	
Speed range	0~400m/min	0~400m/min
Inching speed	30m/min	30m/min
Max blank width	800mm	980mm
Dimension(L*W*H)	15000*1800*1800mm	15000*2000*1800mm
Mechanical weight	约 6.5T	约 7T
Mechanical power	约 16.5KW	约 16.5KW
Max thickness of folded box	15mm	15mm
Compressed air	6 bar	6 bar
Air compressor capacity	10 m ³ /h	10 m ³ /h
Air tank capacity	60L	60L

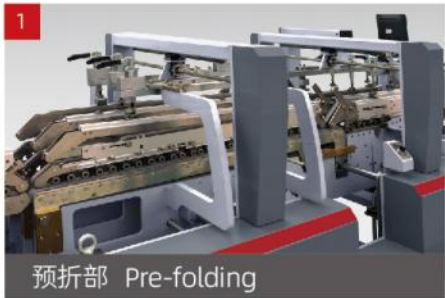

- Left upper left 180°pre-folded
- The third creasing line 135°pre-folded
- With the pre-folding open device for 1st and 3rd creasing line
- One-botton electric lifting, easy to operate, greatly improve the production efficiency, chieved more stable folding process

Box parameter

Box type	Unfolded view	YL-800PC-C	YL-980PC-C
Linear box		L 100 ~ 800 W 130 ~ 800 H 60 ~ 390	L 100 ~ 800 W 130 ~ 980 H 60 ~ 480
Crash lock bottom box		L 100 ~ 800 W 170 ~ 800 H 80 ~ 390	L 100 ~ 800 W 170 ~ 980 H 80 ~ 480
Four corner box		L 130 ~ 800 W 150 ~ 800 H 20 ~ 150	L 130 ~ 800 W 150 ~ 930 H 20 ~ 150
Six corner box		L 130 ~ 800 W 250 ~ 800 H 30 ~ 150	L 130 ~ 800 W 250 ~ 930 H 30 ~ 150

Main feature

- This is a A & B two independent feeders connected box folder gluer, which plays a well role in high efficiency and cost reduction,by the full utilized feeding materials.
- The modular design can meet different requirements from customers,and be more easier installation and operation , also be more effective to solve the production of special-shaped boxes.
- The transmission mode of the whole machine adopts hexagonal axis and multi wedge belts, by this way,machine is more efficient, energy-saving and noiseless.
- Follow the lightweight design principle, reduce energy consumption and achieve more simple and convenient operation.

YL Series

YL-1450/1650AB

Small Format Double Feeder Folder Gluer

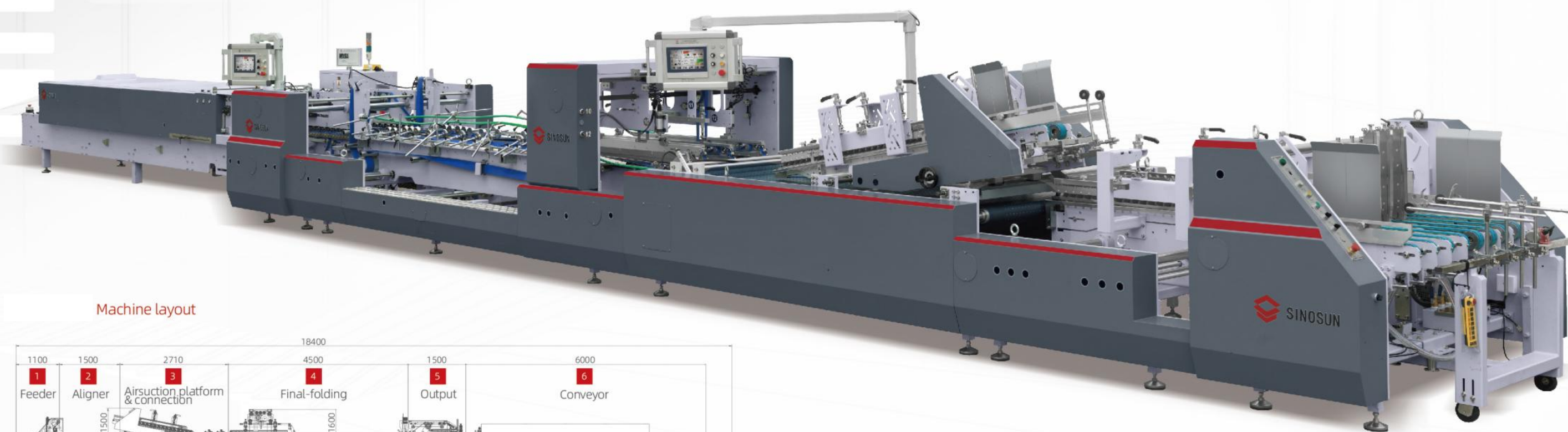

Machine layout

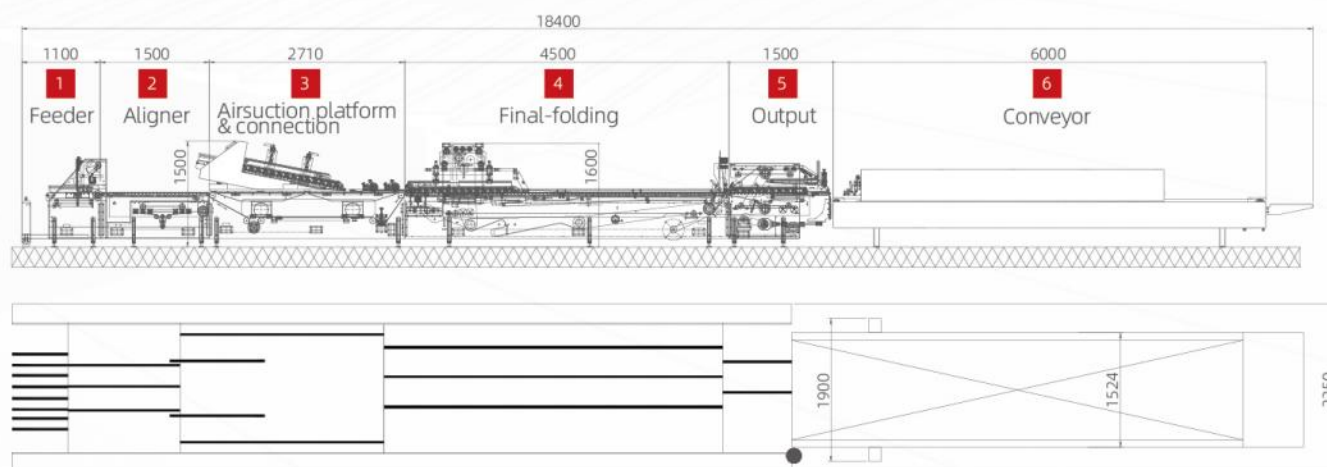

YL Series YL-1450/1650AB

Small Format Double Feeder Folder Gluer

Technical parameter

Model	YL-1450AB	YL-1650AB
Applicable material		
Speed range	0 ~ 150m/min	0 ~ 150m/min
Inching speed	30m/min	30m/min
Max blank width	1450mm	1650mm
Dimension(L*W*H)	18400*2250*1600mm	18400*2450*1600mm
Mechanical weight	约 10T	约 11T
Mechanical power	约 38KW	约 38KW
Max thickness of folded box	15mm	15mm
Compressed air	6bar	6bar
Air compressor capacity	10 m ³ /h	10 m ³ /h
Air tank capacity	60L	60L

Box parameter

Box type	Infolded view	YL-1450AB	YL-1650AB
Linear box		L 120 ~ 1000 W 260 ~ 1450 H 120 ~ 710	L 120 ~ 1000 W 260 ~ 1650 H 120 ~ 810
Flat box		L 180 ~ 1000 W 450 ~ 1450 H 210 ~ 710	L 180 ~ 1000 W 450 ~ 1650 H 210 ~ 810
A feeder of connected box		L 320 ~ 800 W 210 ~ 390	L 320 ~ 800 W 210 ~ 390
B feeder of connected box		L 255 ~ 800 W 455 ~ 1000	L 255 ~ 800 W 455 ~ 1000

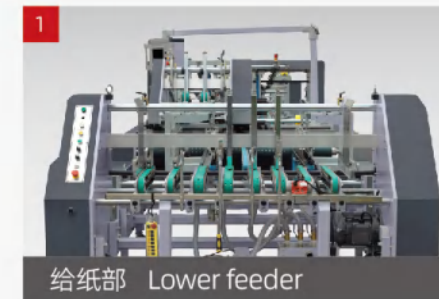

1 给纸部 Lower feeder

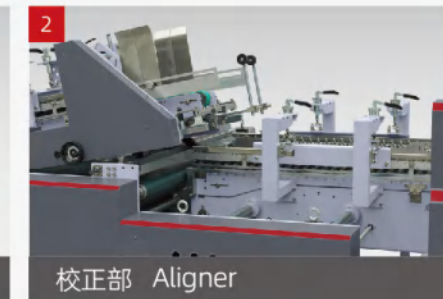

2 校正部 Aligner



3 双拼部 Connecting

- Independent motor drive
- Adjustable vibration motor
- Two sets of adjustable feeder knives
- High performance suction belt is used to realize the stability of paper feeding

- Independent adjustable side aligner, the lower bracket which is not parallel to the wallboard stretches the paper to be transported along a parallel guide device to ensure that the paper is parallel and aligned
- Simple, fast and flexible operation

- Servo motor drive
- The lower conveying platform adopts a large suction belt, which makes the paper run more stably
- Equipped with two high-power suction fans



4 上给纸部 Upper feeder

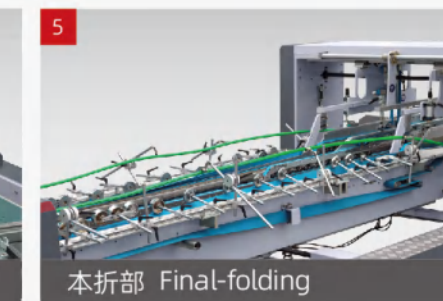

5 本折部 Final-folding

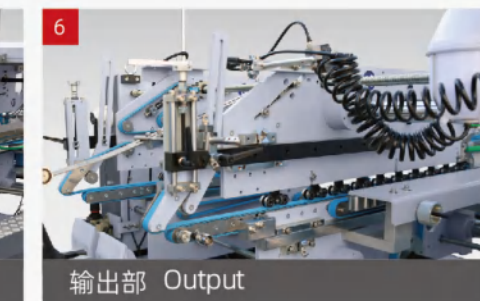

6 输出部 Output

- Independent servo motor drive
- Equipped with left and right baffles and two paper feeding knives
- Independent adjustable side aligner to ensure parallel alignment of the conveying paper

- The upper and lower belt drives ensure smooth paper delivery
- The middle plate adopts pneumatic lifting to facilitate the production of small box type with left and right guide plates

- The telescopic rod of upper and lower brackets can be adjusted separately
- Equipped with automatic belt tension adjustment system



7 输送机 Conveyor

- Upper and lower independent motor drive
- According to different carton lengths, motors are equipped to control the upper part of the conveyor to move forward and backward
- Pneumatic pressure regulating system, easy to adjust, can effectively ensure uniform fitting pressure

Main feature

- This is specialized folder gluer for stereo products, which can help to make three-dimensional envelope, cosmetic box, pharmaceutical box, underwear box, mobile protective film box, other digital products box etc.
- Equipped with hot melt glue system device, fast forming boxes and easy to shift between different boxes.

YL Series

YL-650TD

Stereo Box Automatic Folder Gluer

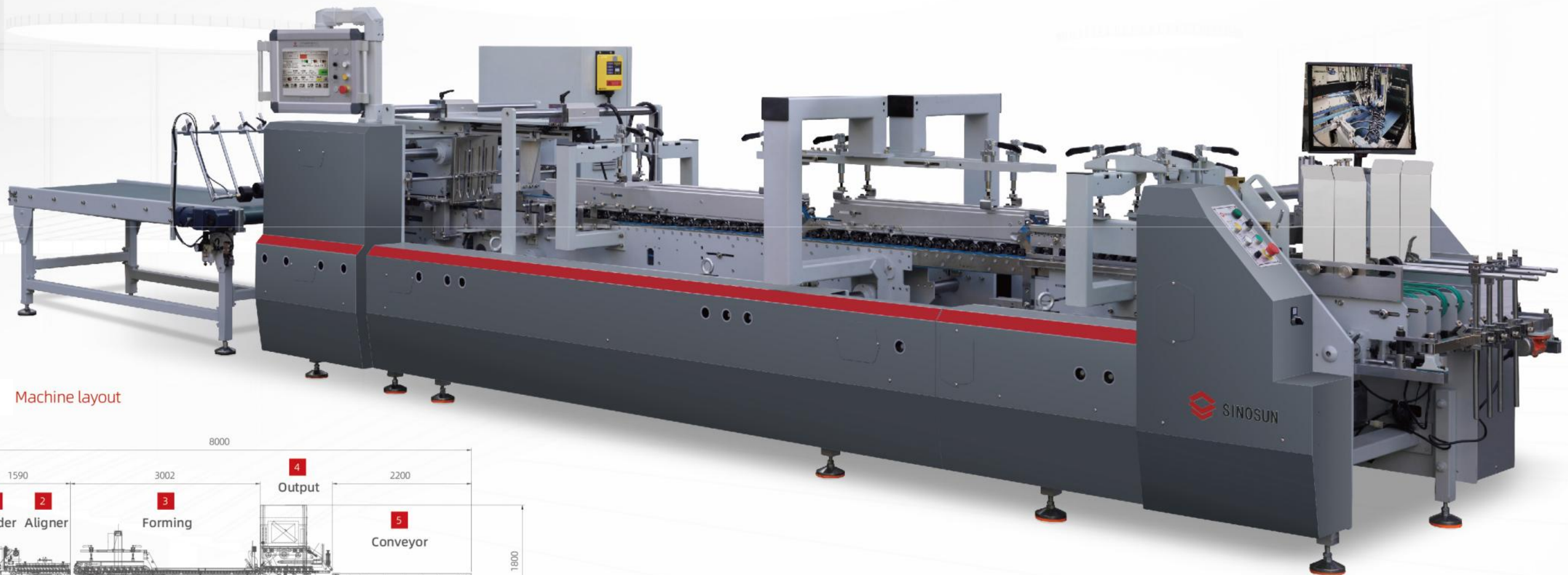

Machine layout

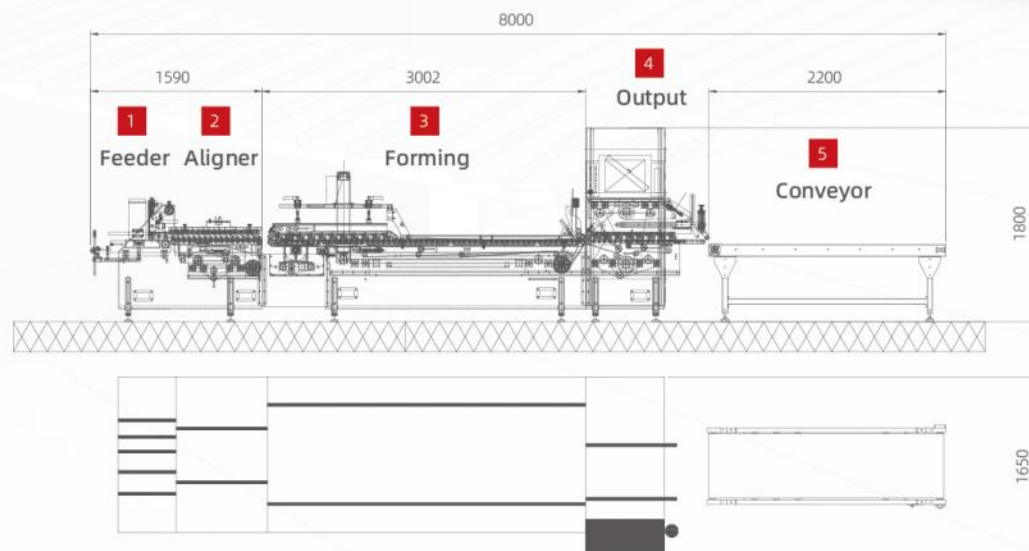

YL Series

YL-650TD

Stereo Box Automatic Folder Gluer

Technical parameter

Model	YL-650TD	
Applicable material	200 ~ 650g/ m ²	(cardboard)
Speed range	0 ~ 120m/min	
Inching speed	30m/min	
Max blank width	650mm	
Dimension(L*W*H)	8500*1650*1800mm	
Mechanical weight	约 2.6T	
Mechanical power	约 11KW, AC220V/380V	
Max thickness of folded box	20mm	
Compressed air	6bar	
Air compressor capacity	10 m ³ /h	
Air tank capacity	60L	

Box parameter

Box type

Unfolded view

Stereo box

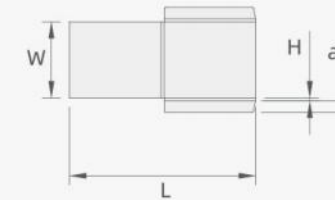

YL-650TD

L	150 ~ 500
W	100 ~ 300
H	2 ~ 20
a	15 ~ 30



- Independent motor drive
- Adjustable vibration motor
- Two sets of adjustable feeder knives

- Independent adjustable side aligner, the lower bracket which is not parallel to the wallboard stretches the paper to be transported along a parallel guide device to ensure that the paper is parallel and aligned
- Simple, fast and flexible operation

- Hot melt glue help forming and fixing
- Servo matching with mold for more accurate forming and positioning

- Both left and right sides equipped with positioning wheels, can help to form more well three-dimensional effect

Main feature

- A variety of formats to meet the various types of box-type customer's production needs, Machine is combined with stable, fast, convenient, flexible, accurate, efficient and other properties. Modular design, to achieve different functional configurations, providing a perfect production solution

GL Series

GL-650/800/980PC-A

High-speed Multifunctional Automatic Folder Gluer



Machine layout

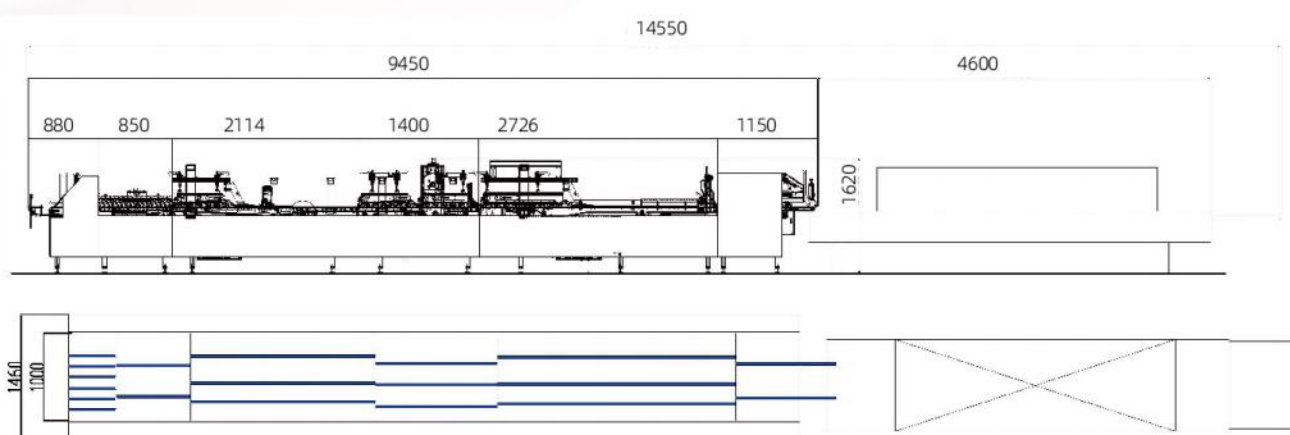

GL Series

GL-650/800/980PC-A

High-speed Multifunctional Automatic Folder Gluer

Technical parameter

Model	GL-650PC-A	GL-800PC-A	GL-980PC-A
Suitable material	200-650g/ m ² Cardboard	200-800g/ m E/F/N 瓦楞纸 Flute corrugated board	Cardboard
Speed range	MAX.300m/min		
Inching speed	30m/min		
Max feeding width	650mm	800mm	980mm
Dimension(L*W*H)	14550*1310*1620mm	14550*1460*1620mm	14550*1580*1620mm
Mechanical weight	5T	6T	7T
Mechanical power	10.8KW	14.5KW	14.5KW
Max thickness of folded box	12mm	15mm	15mm
Compressed air	6 bar		
Air compressor capacity	10m ³		
Air tank capacity	60L		

Box parameter

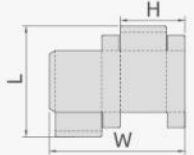
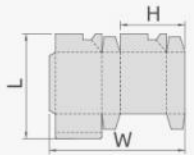
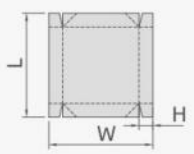
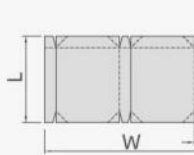
Box type	Unfolded view	GL-650PC-A	GL-800PC-A	GL-980PC-A
Linear box		L 800-120mm W 650-150mm H 315-70mm	800-120mm 800-150mm 390-70mm	800-120mm 980-150mm 480-70mm
Crash lock bottom box		L 800-120mm W 650-170mm H 315-80mm	800-120mm 800-170mm 390-80mm	800-120mm 980-170mm 480-80mm
4 Corner box		L 800-120mm W 750-150mm H 150-30mm	800-120mm 750-150mm 150-30mm	800-120mm 950-150mm 150-30mm
6 Corner box		L 800-120mm W 750-260mm H 120-30mm	800-120mm 750-260mm 120-30mm	800-120mm 950-260mm 120-30mm

YL Series

MACHINE CATALOGUE

YL-650FD

Scratch-resistant Paper Feeder

YL-650FD scratch-resistant feeder, is an auxiliary paper feeding device in the front of the folder gluer, which is suitable for the gold & silver cardboard, reverse UV, and oil polished boxes that are easy to be scratched. This feeder is linkage with the automatic folder gluer by pre-feeding paper, auxiliary paper feeding, main paper feeding and upper suction belt feeding parts. The manual pre-feeding can realize non-stop, stable and uniform paper feeding, and ensure that the final paper box surface is not scratched.

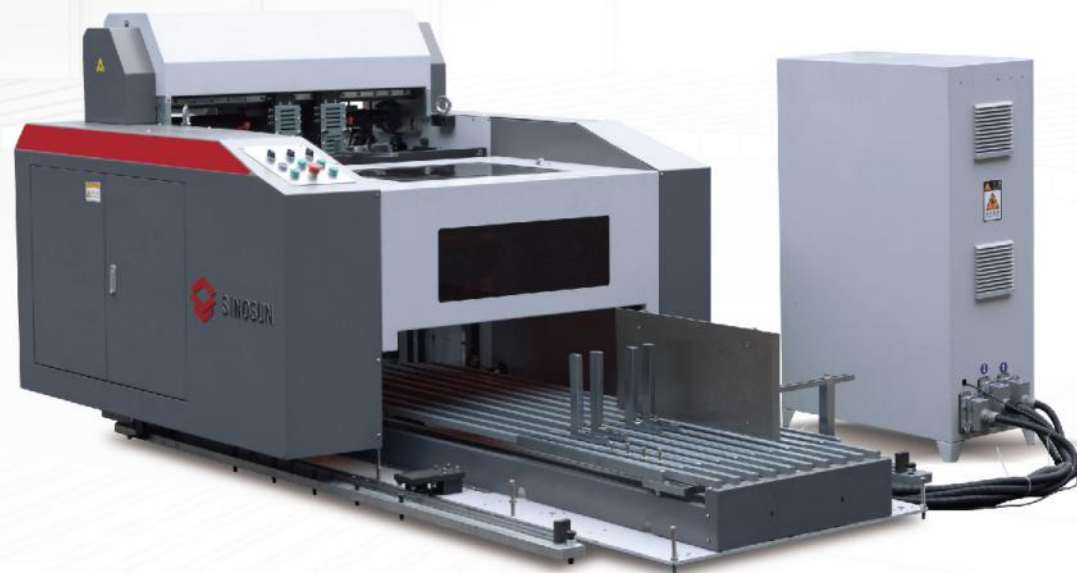

Technical parameter

Model	YL-650FD
Paper feeder belt height	790mm
Maximum speed of paper feeding belt	约 260m/min
Maximum pre feeding paper height	200mm
Minimum box size L * W	150*150mm
Maximum box size L * W	450*550mm
Dimension	2610*1470*1240mm
Power	约 8KW
Total mechanical weight	约 0.9T
Voltage	220V,3PH
Compressed air pressure	8bar

Main feature

- Independent motor driven, can linkage with any brand folder gluer
- Suitable for boxes with various surface treatments that are easy to be scratched (such as gold & silver cardboard, reserve UV, oil polished treatments)
- Manual pre-feeding ensure non-stop paper feeding
- The upper air suction feeding also can help avoid scratch on box surface, to improve the better quality and higher efficiency

YL Series

MACHINE CATALOGUE

YL-500ST

Automatic Stacker

YL-500ST automatic stacker is the auxiliary box collection device which is linkage with end of the folder gluer. With the transfer turning function, it realizes the 90° turn over conveying. It also increases the neatness and tightness of the box arrangement when box comes collection step. With high speed counting and collection, help to reduce labour and improve final packing efficiency.



Technical parameter

Model	YL-500ST
Width	100 ~ 450mm
Length	100 ~ 500mm
Dimension	3550*2000*1350
Power	1KW
Total mechanical weight	0.6T
Voltage	220V,3PH
Compressed air	1bar

Main feature

- Independent motor driven, can linkage with any brand folder gluer
- Can collect many kinds of boxes such as straightline box, double sides box, crash lock bottom box, four corner box and fine flute corrugated box
- Manual/Automatic dual mode, automatic mode can coordinate with folder gluer automatically, no need adjustment
- Horizontal delivery platform can be electrically adjusted to fit different size boxes



Optional configuration

01 四六角功能
4/6 Corner Box



02 0-180° 转角
0-180° Turning



03 质量检测
Quality Inspection



04 模切连点打断
Die-cut Interruption



05 盲文
Braille



06 爬坡
Climbing Bottom



07 记忆存储
Data Memory Storage



08 立体盒
Stereo Box



09 喷码联线
Online Inkjet Printing



10 自动贴窗
Automatic Window Patching



11 自动收盒
Automatic Stacker



12 自动打包
Automatic Packaging



13 自动送料
Automatic-Feeder



14 防刮花飞达
Scratch-resistant Feeder



Customized 120g Paper Pochette Bag Automatic Making Processes

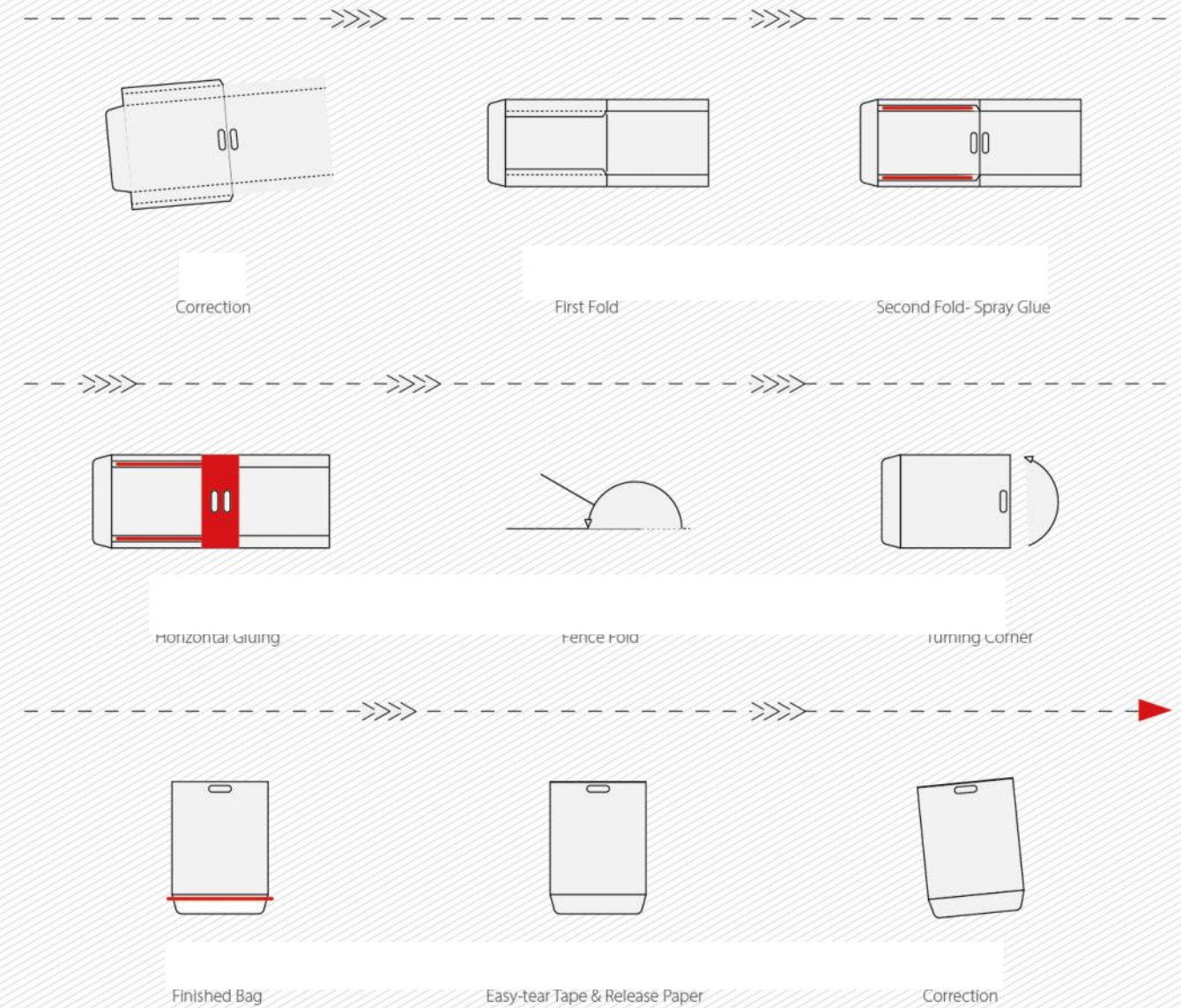

Wide Application To Various Box Types, Create Unlimited Possibilities For You!

